

2026

Sample floor plans

# 1 Bed / 1 bathroom (Flagship Plan)

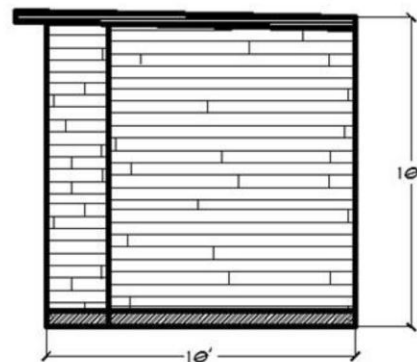
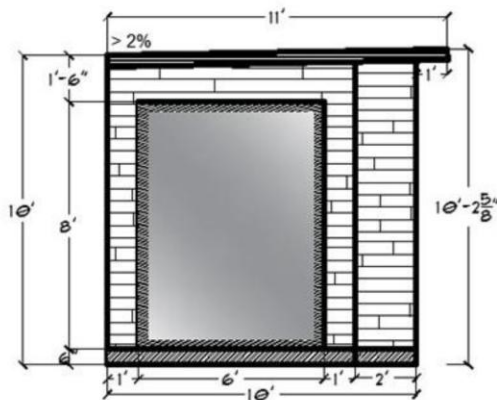
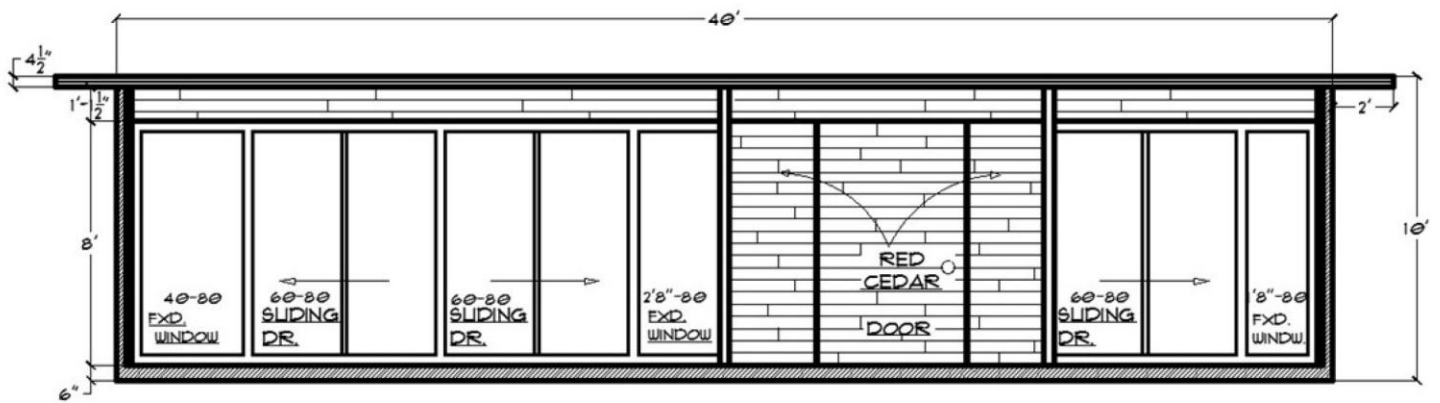
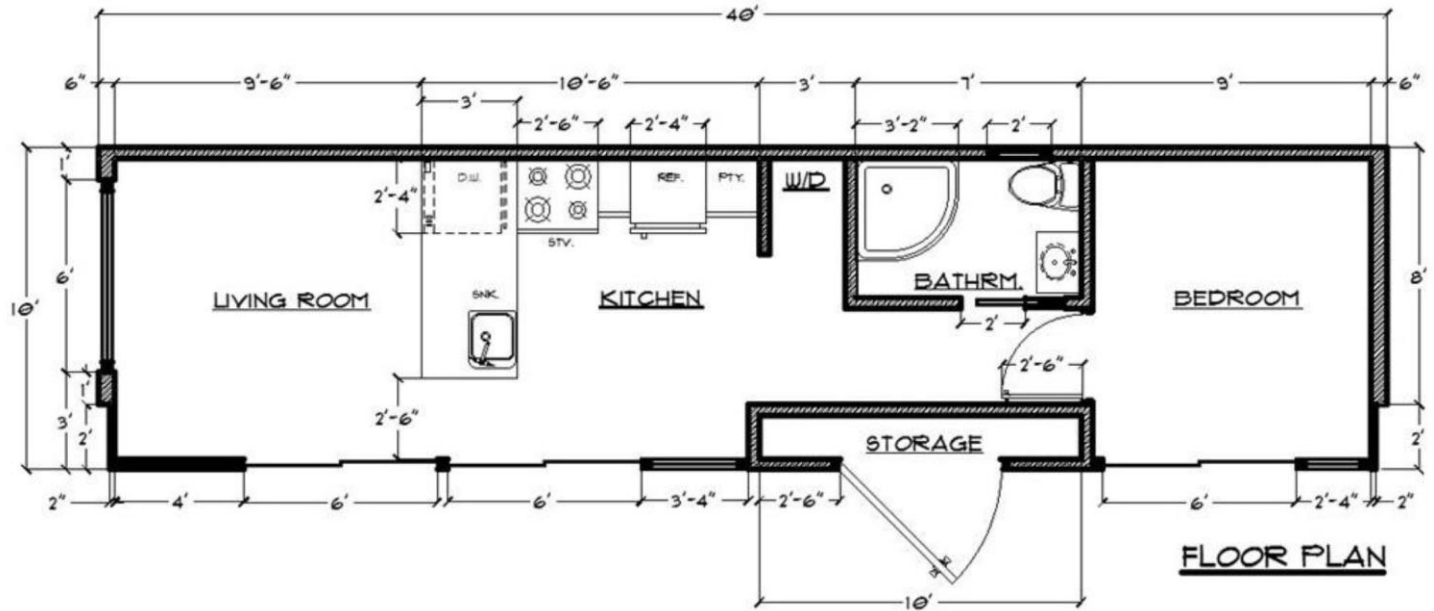

# 1 Bed / 1 bathroom

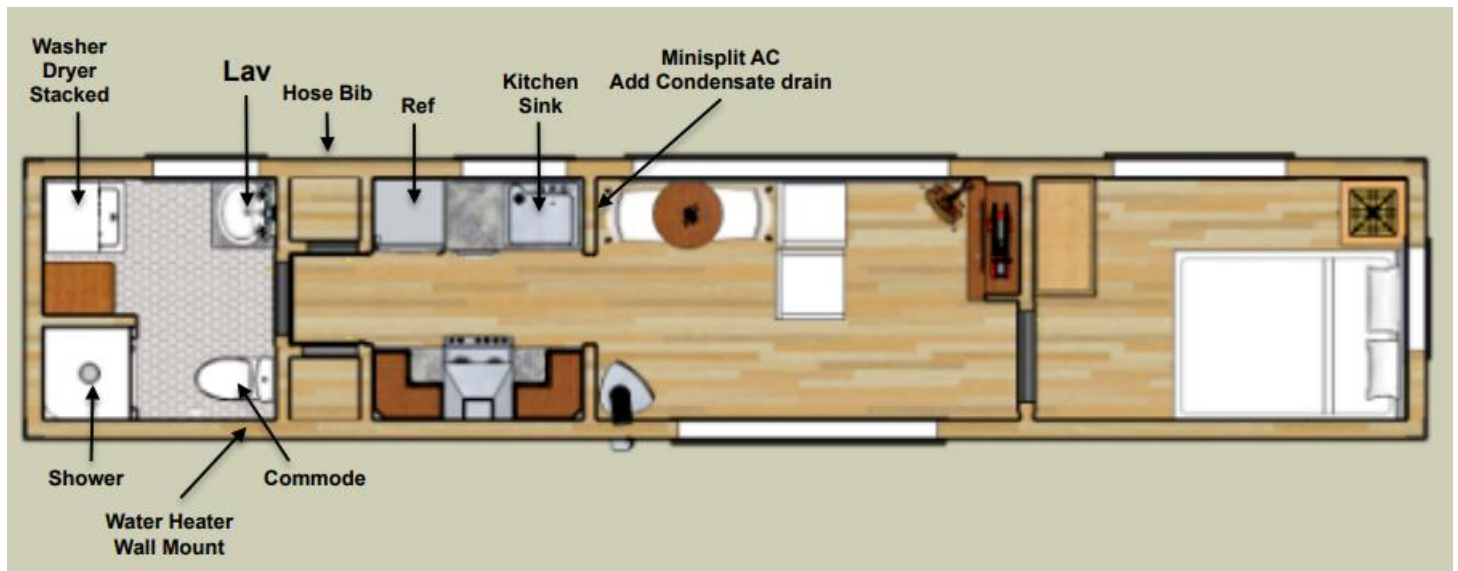
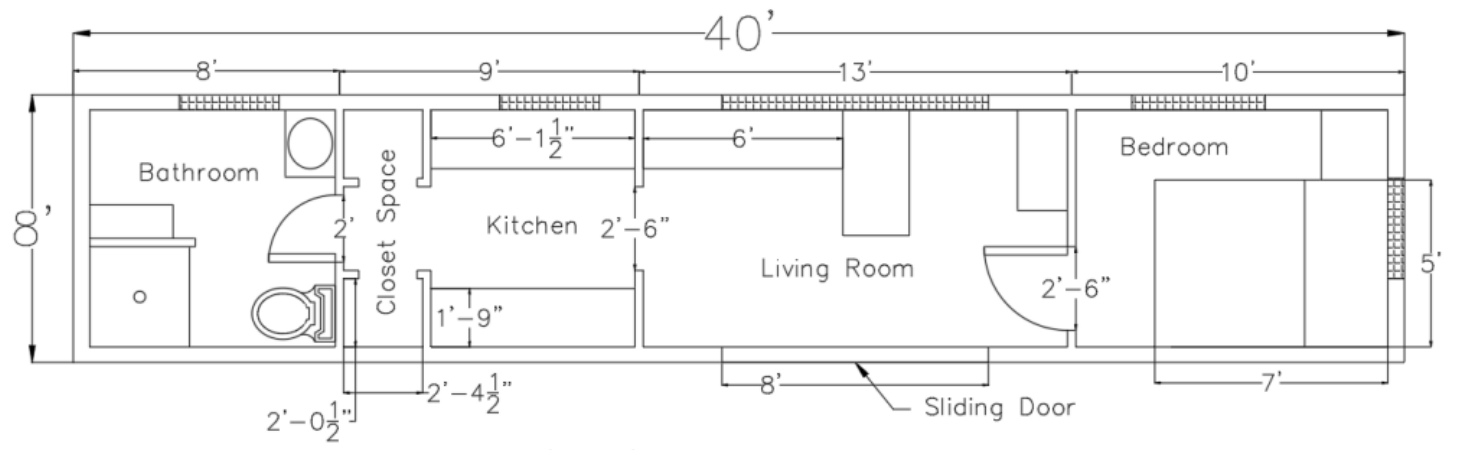
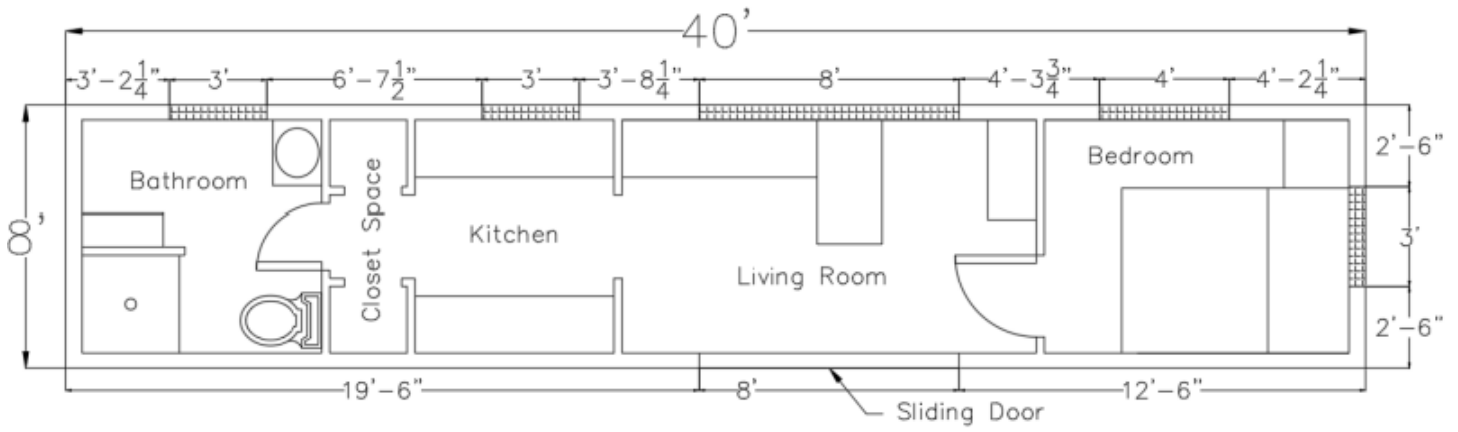

# 1 Bed / 1 bathroom (KC1)

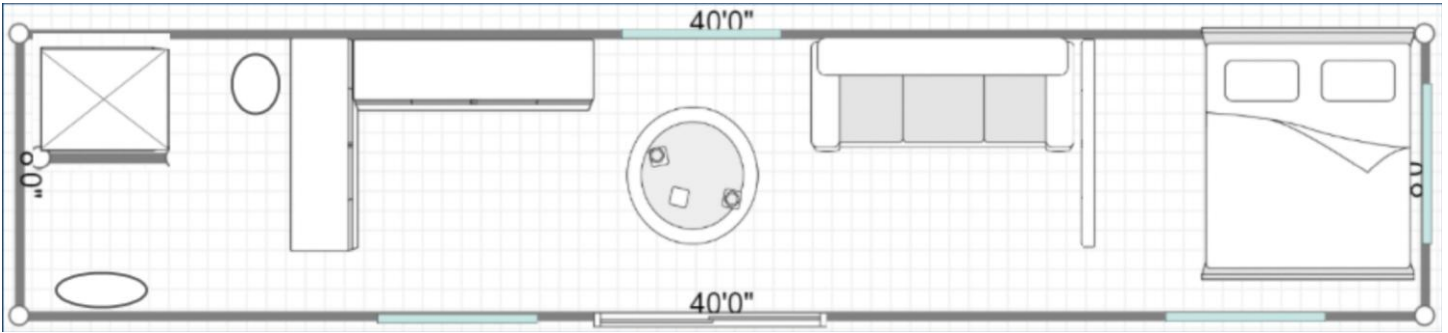

# 1 Bed / 1 bathroom (KC2)

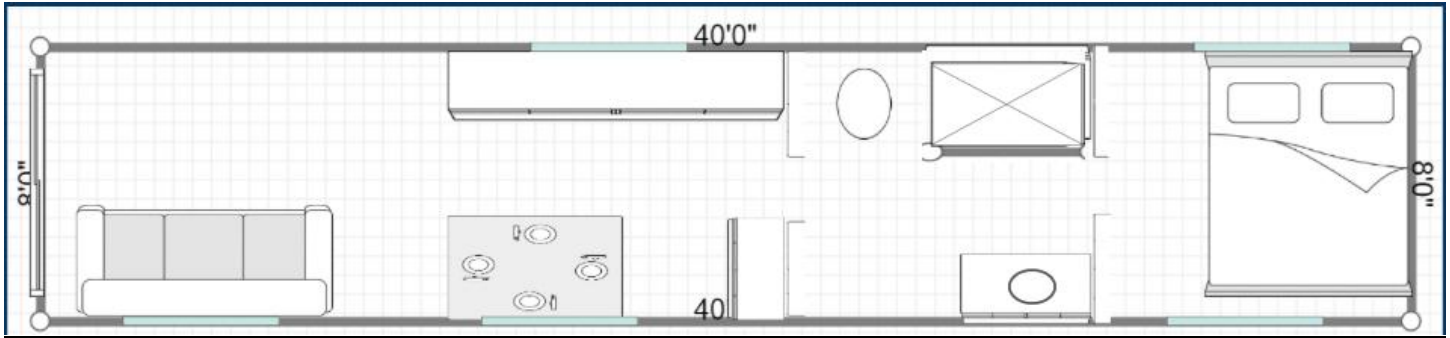

## 2 Bed / 1 bathroom (Showcase)

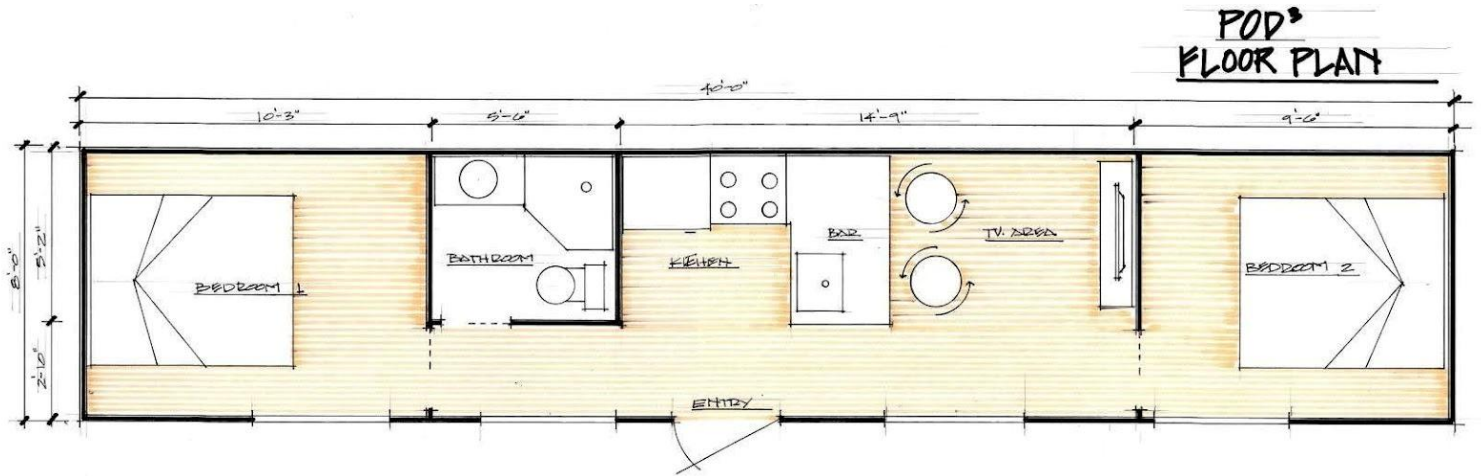

## 2 Bed / 2 bathroom

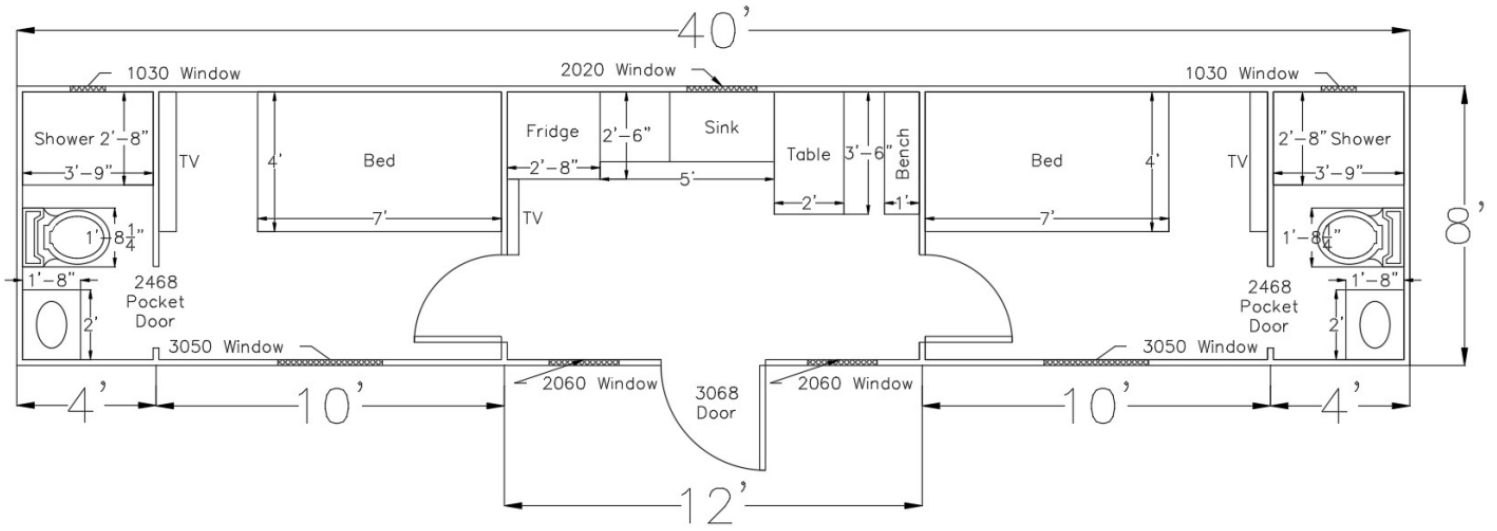

## 2 Bed / 1 bathroom

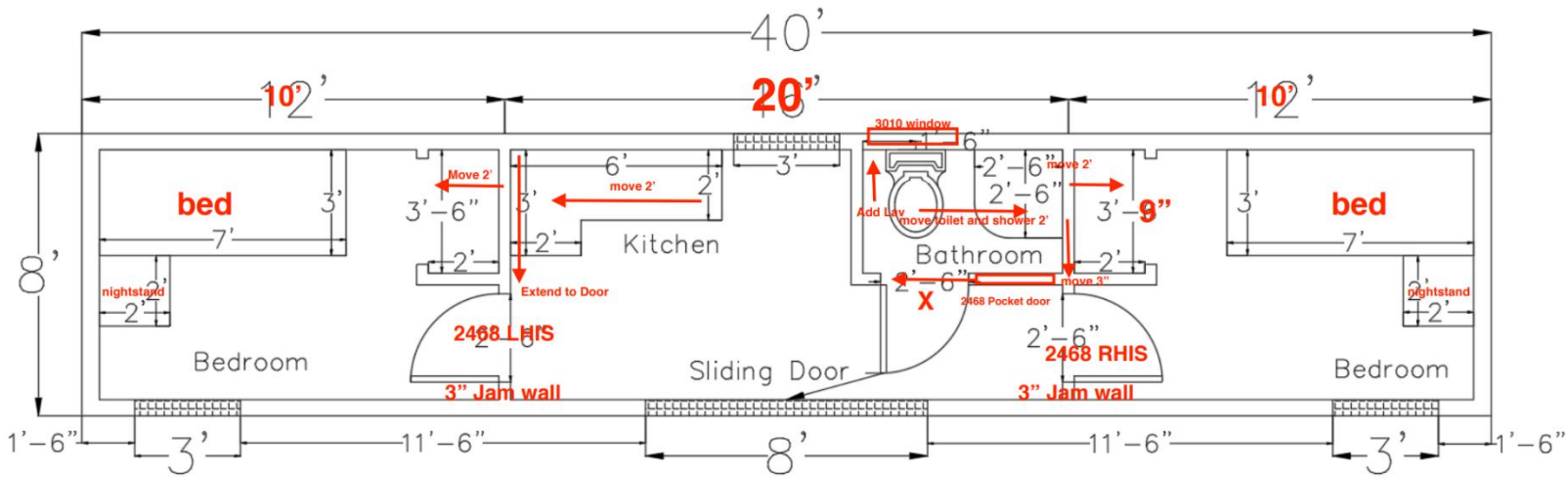

# Bunkhouse

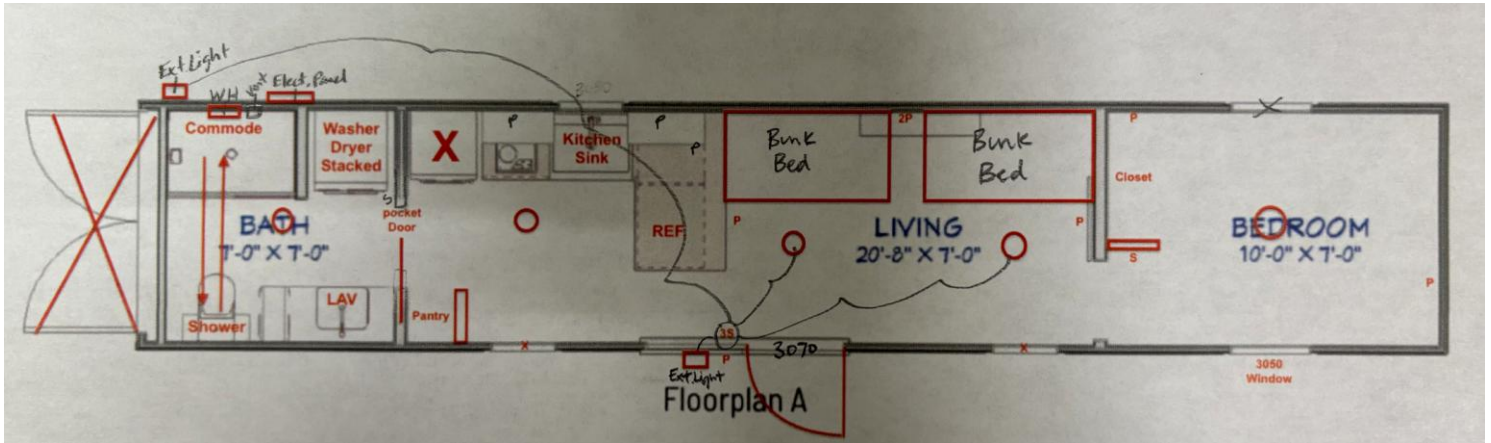

**Bunkhouse**



# 1 Bed / 1 Bathroom + Garage + Rooftop Deck

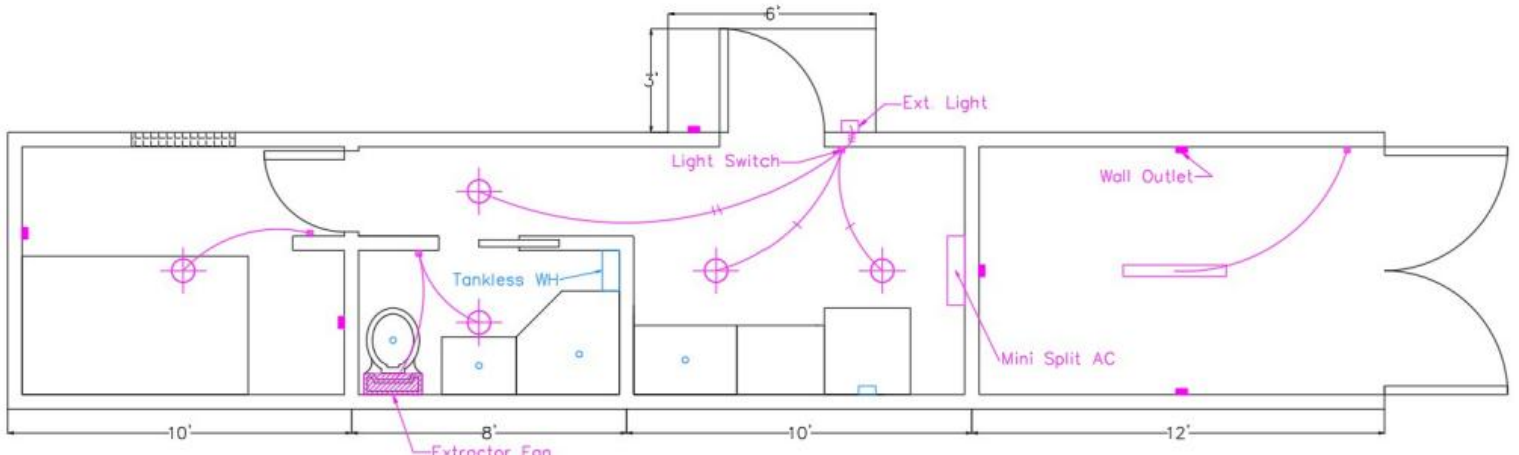
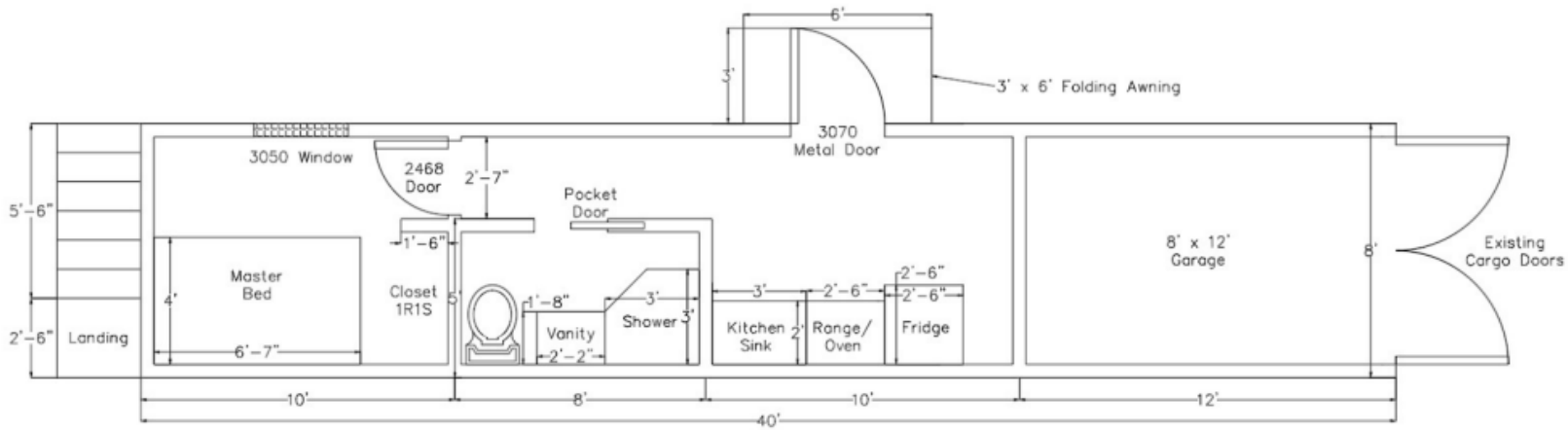

8' x 40' Container 6  
Electric and Water Plan

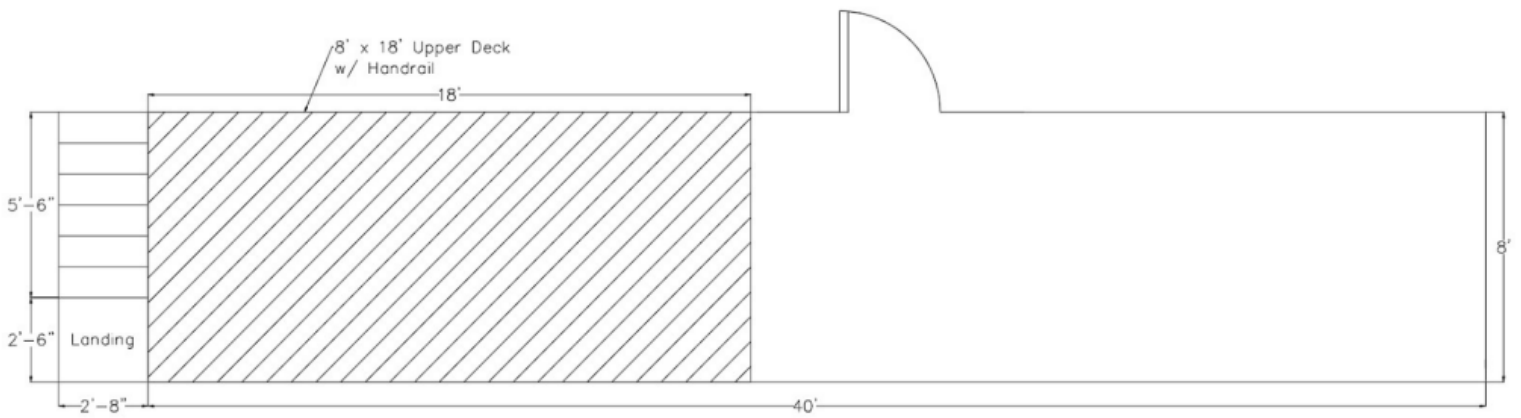

8' x 40' Container 6  
Upper Deck View

# 1 Bed / 1 Bath + Garage + Rooftop Deck

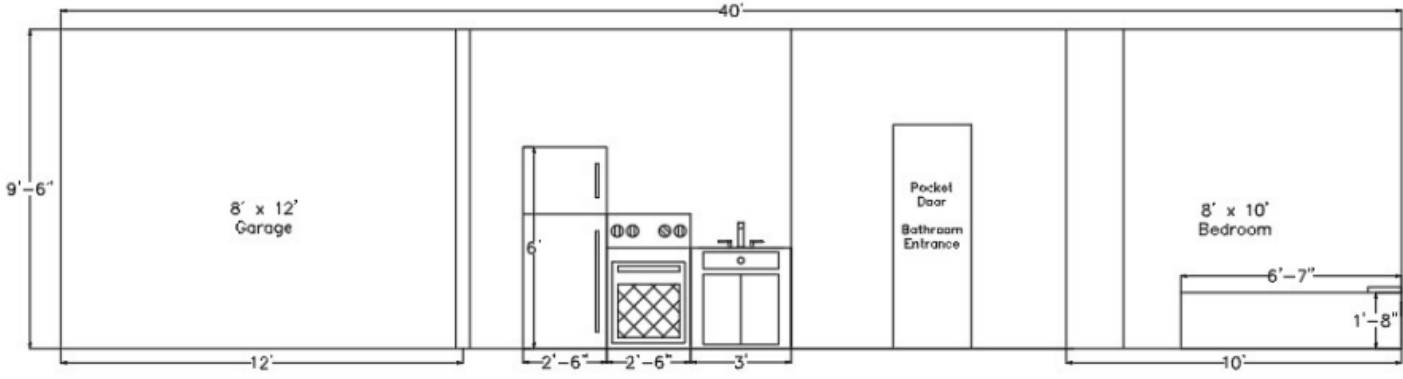

8' x 40' Container 6  
Front Internal Elevation  
4/16/2025

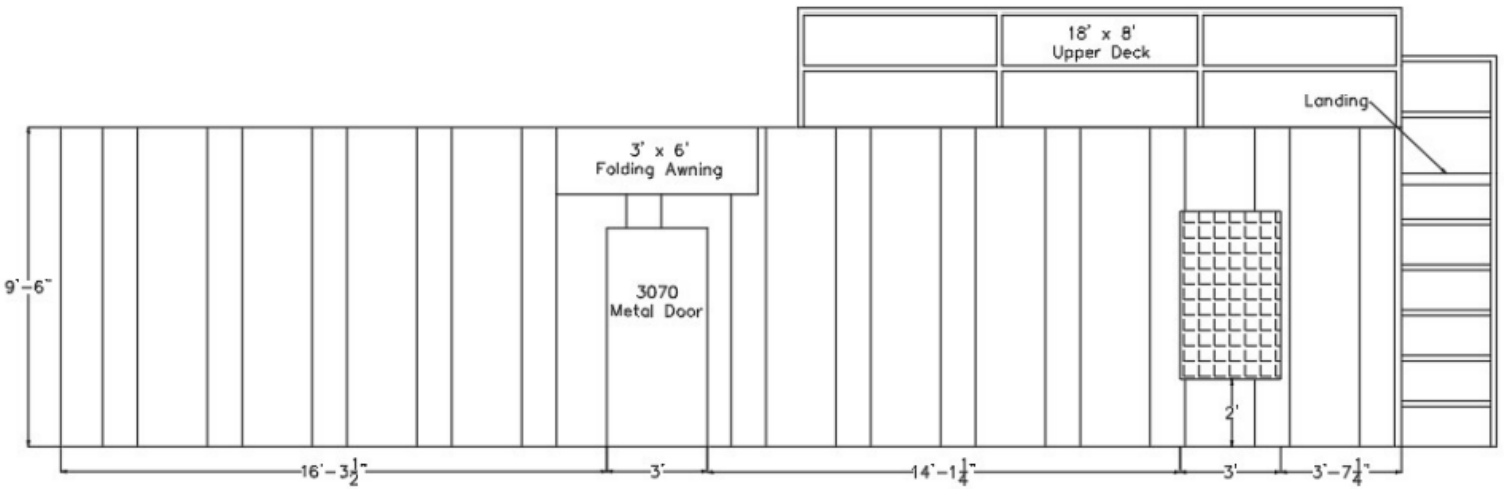

8' x 40' Container 6  
Front External Elevation

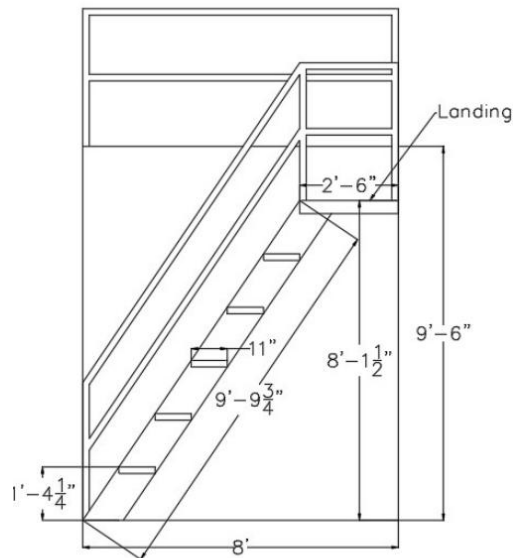

8' x 40' Container 6  
Side External View

## 20-foot container (option#1)

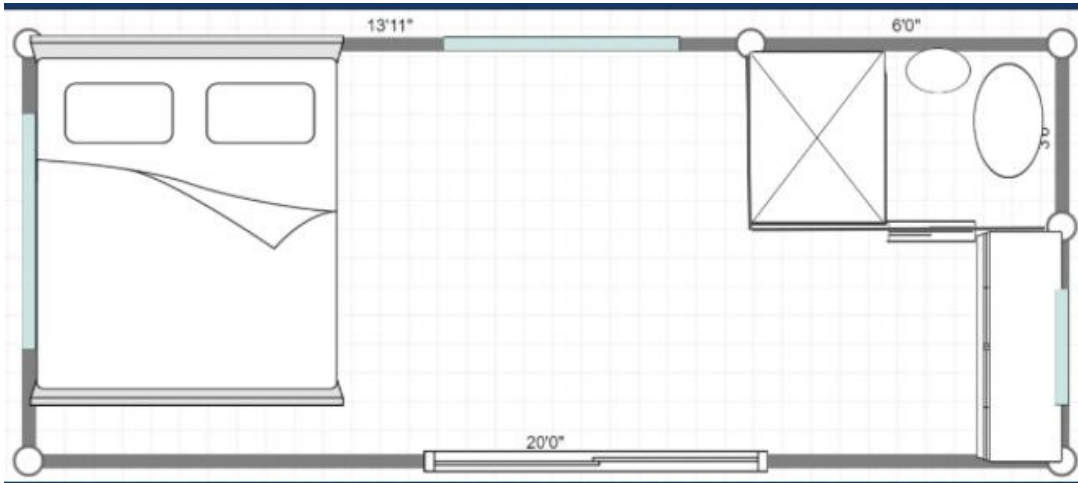

## 20-foot container (option#2)

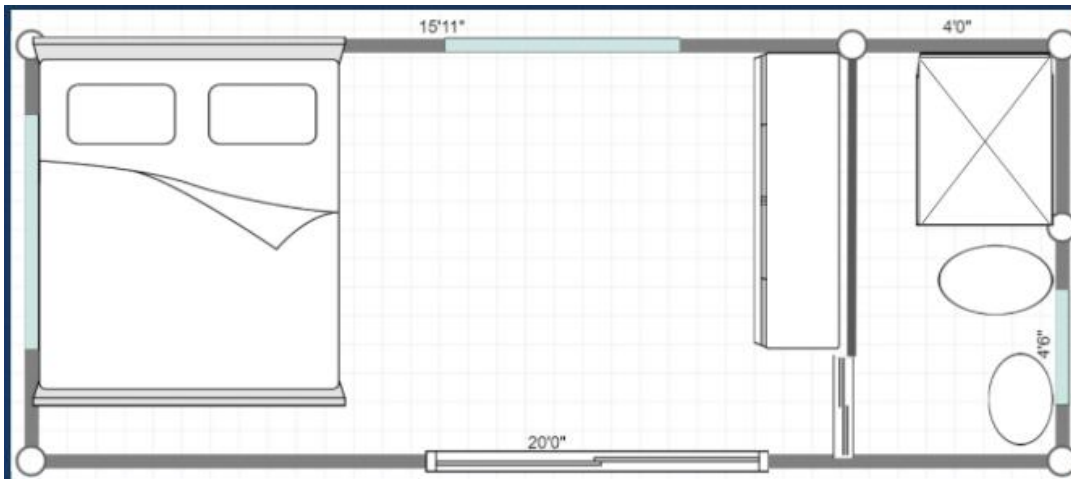

## Example

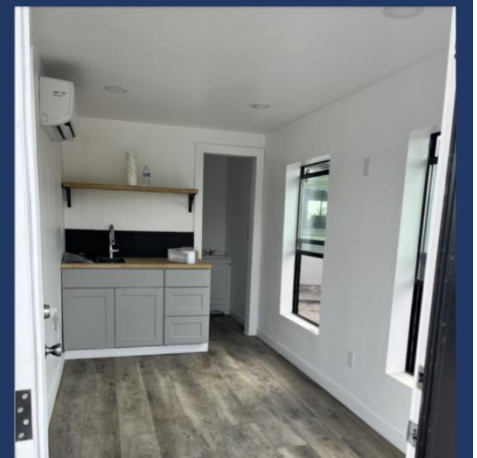

### **20 foot container (option#3)**

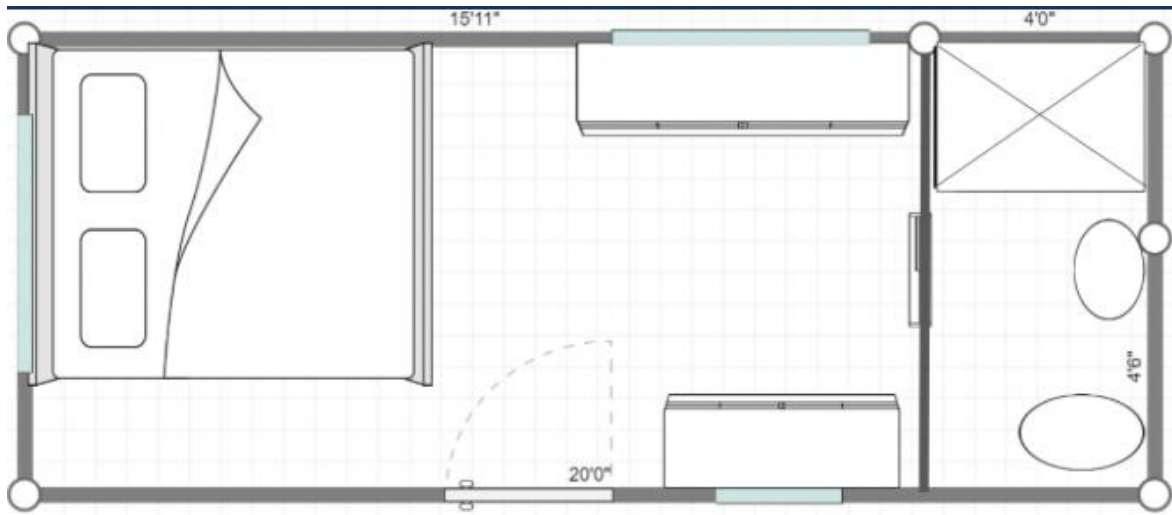

### **20 foot container (option#4)**

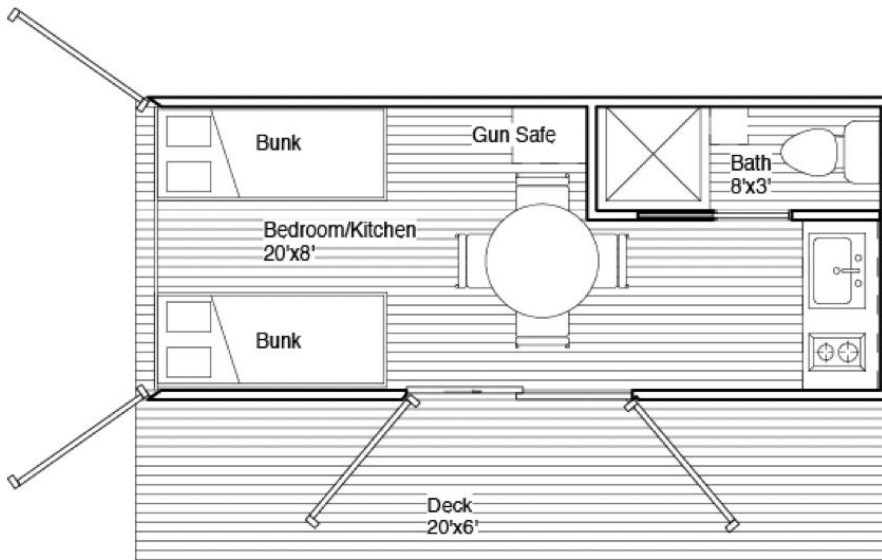

# 2 Bed / 2 bathroom (The Megan)

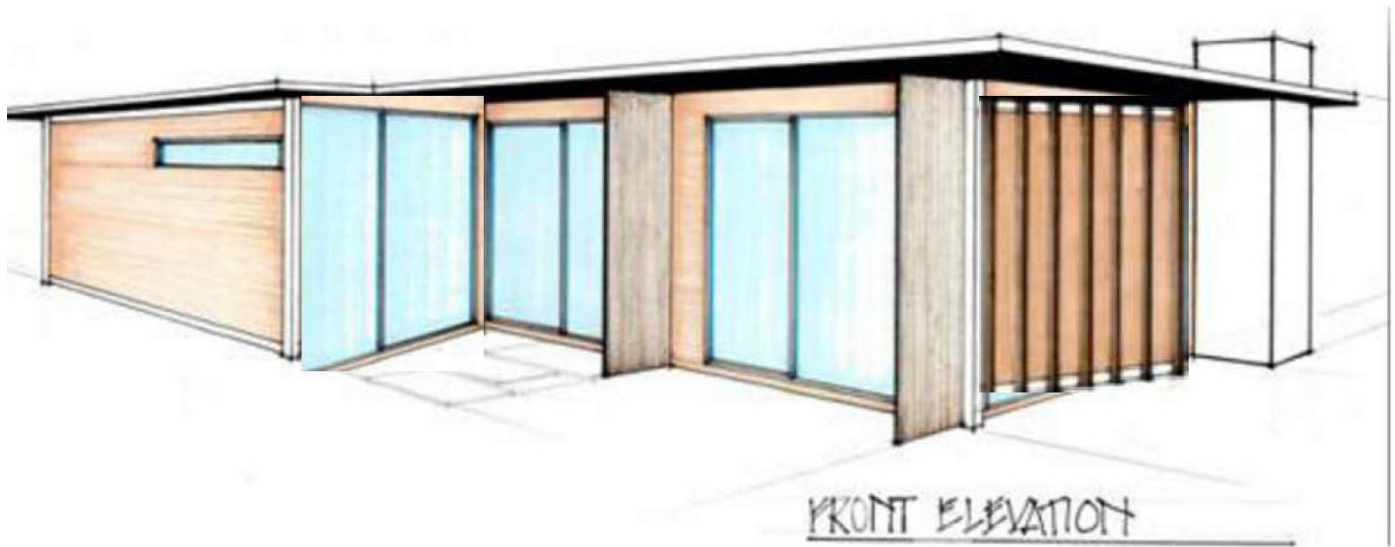
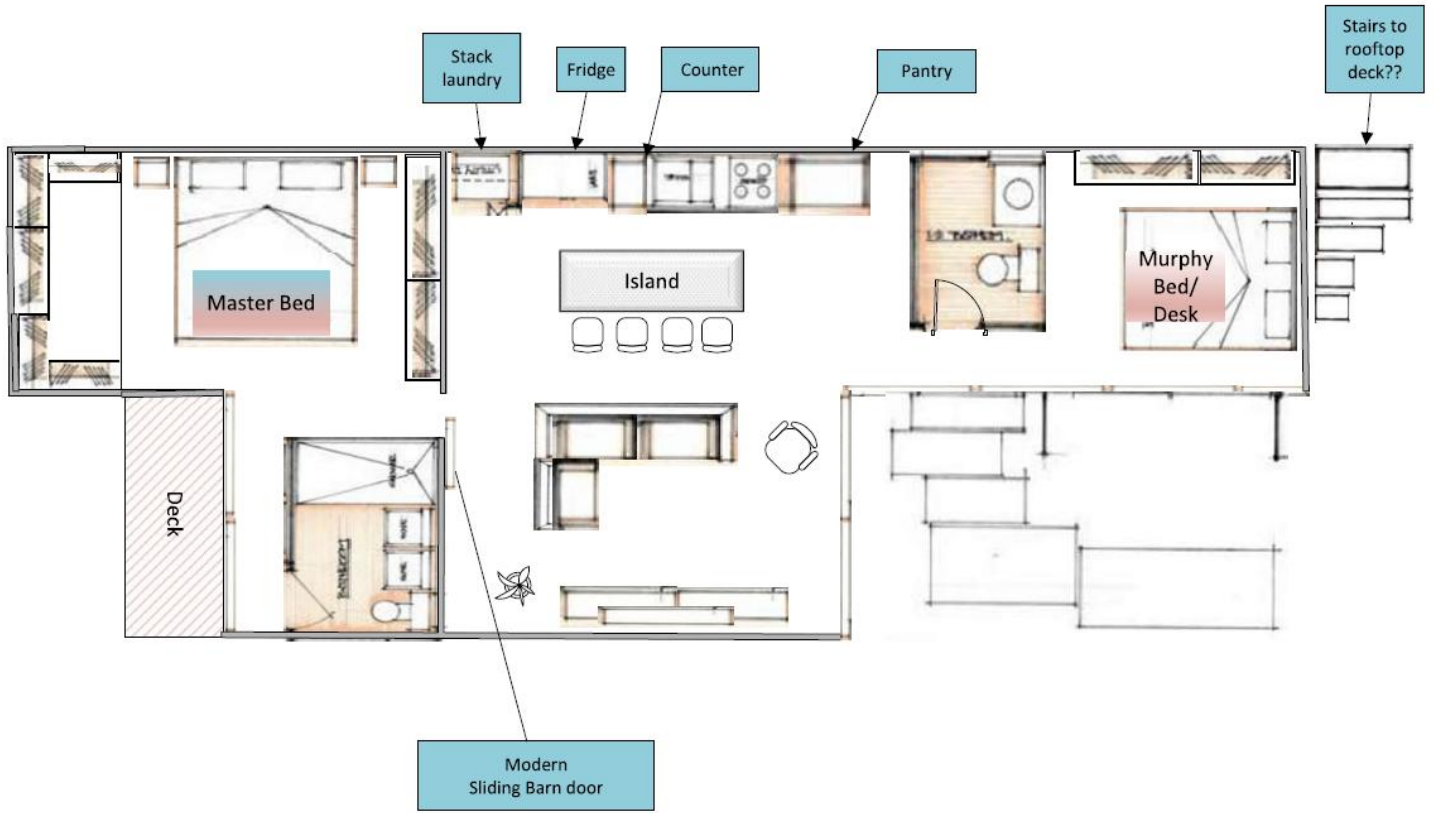

# Stacked 2 Bed / 1.5 Bath

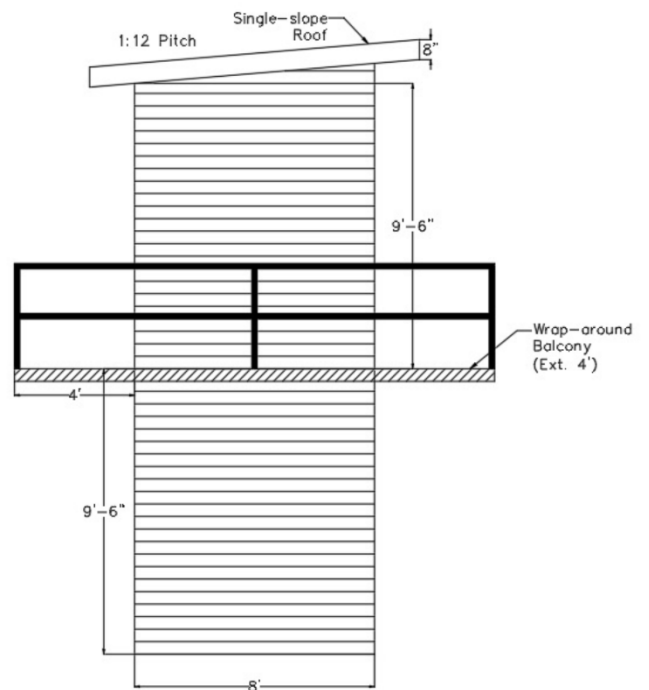
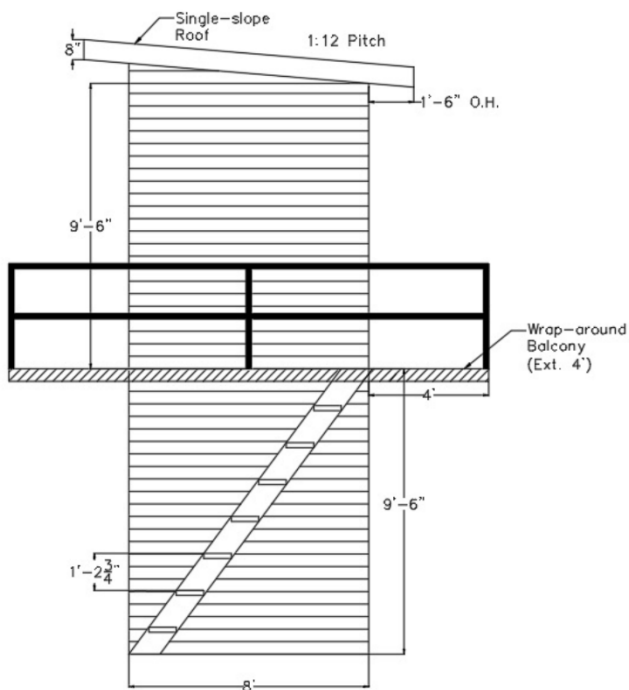
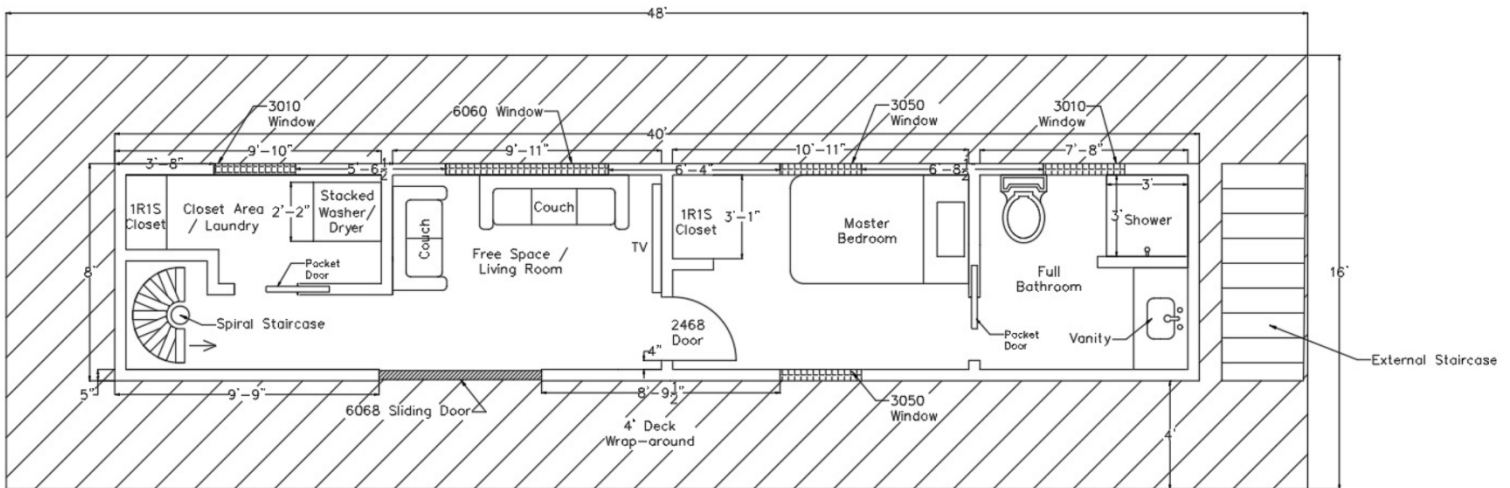
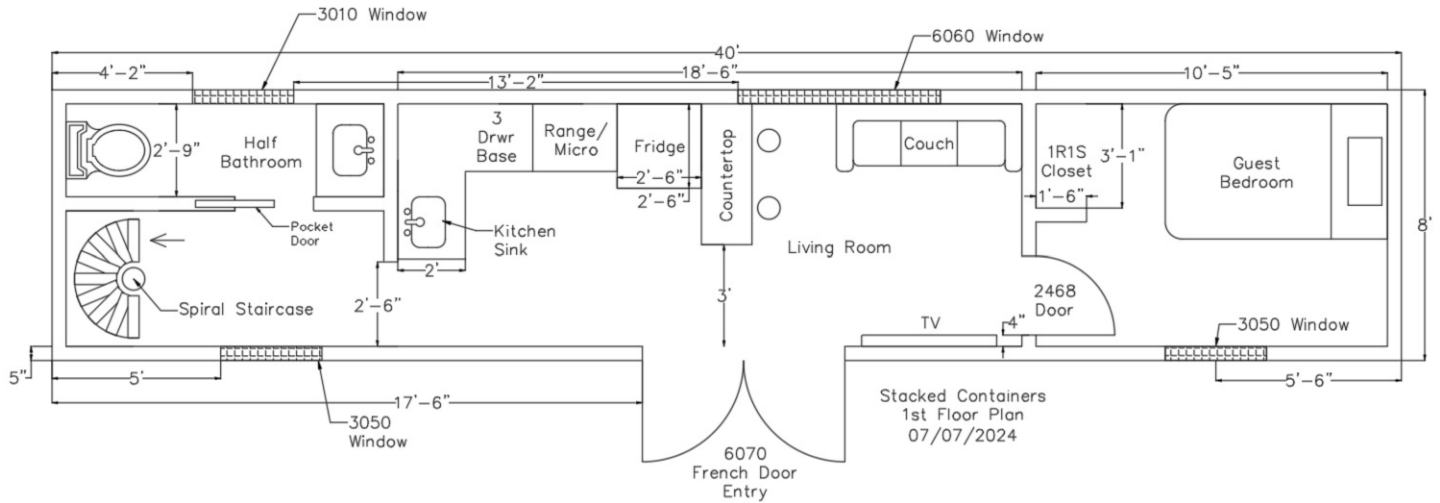

# Stacked 2 Bed / 1.5 Bath

